



Norton Notice

The Newsletter of The Northern California Branch

NO. 58

March 1983

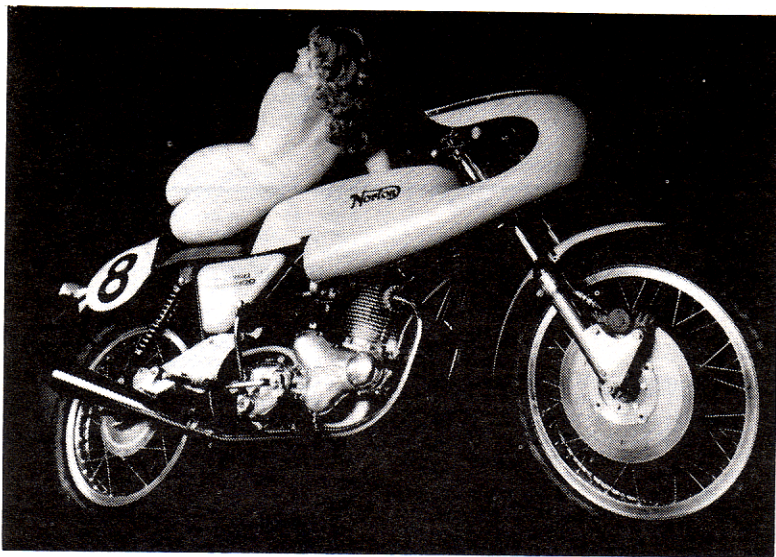

**HERE'S
PAPPY! P9.6**

Norton Notice

The Newsletter of The Northern California Branch

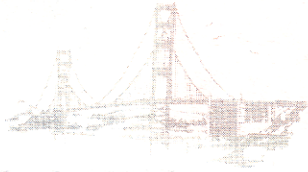

is published monthly by the NORTHERN CALIFORNIA BRANCH of the NORTON OWNERS CLUB. Its sole purpose is to inform and entertain members regarding all aspects of the Norton motorcycle, including history, technical advice and preservation of the Marque.

NORTON NOTICE is a reflection of its readership who are encouraged to submit any article, technical tip, photograph (original or otherwise), so long as it is in good taste, so that other Norton enthusiasts can enjoy it. For Branch members who cannot attend meetings and rides, The Notice affords an excellent opportunity to share experiences and information with the membership at large, and to bring the Branch members closer together. Deadline for items to be submitted to this publication is the 21st of each month.

PRESIDENT

Tom Dabel
730 Linda Flora St.
San Jose, Ca 95127
(408) 272-0369

MEMBERSHIP SECRETARY TREASURER

Phil Radford
1020 Ellis Ave
San Jose, Ca 95125
(408) 293-4548

VICE PRESIDENT

Rich Stevenson
(415) 658-9941

EDITORS OF THE NOTICE

Robert Briscoe
Northwind Productions
3232 Balboa
San Francisco, Ca
94121
Brian Halton (415)
982-7242

RECORDINGS SECRETARY

Tim Coburn
(415) 854-4364

MEMBERSHIP IN THE NORTHERN CALIFORNIA BRANCH OF THE NORTON OWNERS CLUB IS AVAILABLE IN THREE CATEGORIES.

FULL MEMBERSHIP \$25.00 per year.

ASSOCIATE MEMBERSHIP \$10.00 per year.

SOCIAL MEMBERSHIP \$10.00 per year.
(OVERSEAS ASSOCIATE OR SOCIAL MEMBERSHIP DUES ARE U.S. \$20.00 per year.)

ALL MEMBERSHIPS DUES ARE PAYABLE TO THE BRANCH TREASURER. RENEWAL DUES ARE PAYABLE AT THE END OF THE INDIVIDUALS MEMBERSHIP YEAR, THAT MONTH BEING DESIGNATED BY THE LAST NUMBER OF THE MEMBERSHIP NUMBER LOCATED ON THE MAILING LABEL OF THE NOTICE. FOR EXAMPLE:

828/2

DENOTES MEMBER NUMBER 828 WITH HIS DUES EXPIRING ON THE 1ST OF FEBRUARY. PLEASE SEND ALL CHANGES OF ADDRESS TO THE MEMBERSHIP SECRETARY/TREASURER ONLY.

FULL MEMBERSHIP give membership in the NORTON OWNERS CLUB with its benefits and privileges, such as bi-monthly issues of ROADHOLDER magazine sent directly from England, keeping members informed of Norton owners activities all around the world. Use of a low-cost Spares Program which allows one to buy Norton Spares directly from England at significant savings, and full voting privileges at all NOC and Branch meetings.

ASSOCIATE MEMBERSHIP is established for any Norton owner wishing to be associated with the Northern Californian Branch and are welcome at all meetings, rides and other functions. Members are urged to become Full Members once they become familiar with the NOC benefits.

SOCIAL MEMBERSHIP is established for Norton enthusiasts who have not as yet bought a Norton motorcycle but would like to be included in club functions. They do not have Branch voting rights.

THIS MONTHS COVER-From the Dave Cronin Collection. Many Thanks!

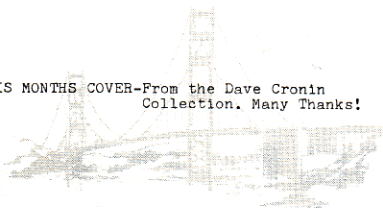

MINUTES



MINUTES OF FEBRUARY 10, 1983 MEETING

Well, we won't have Art Sirota to kick around any longer. Tom Dabel, the new president, called the February meeting to order at Rick's Swiss Chalet with about 35 or 40 members present. Following introduction of the other new officers, Tom noted that the next club ride would leave from Sausalito at 10 a.m., February 13th. As per the usual custom, in case of rain the ride is postponed to the following Sunday, same time and place. Since Rich Stevenson is ride coordinator, he is presumably the official Norton weatherman also.

Some discussion and a lot of confusion about the NOC sponsored "quiz". Jan Barton successfully avoided draft as our representative. Now that he works on Ferrarri's, he probably can't remember how many cylinders a Norton has. Any technical or trivia freaks should contact Tom Dabel or Tom Horton for details.

Gene Austin mentioned the upcoming CAMA rally in Hanford, April 23rd, 24th, 1983. \$20.00 will allow you to show 1 or more bikes. Gene has the application forms. Showing or not, it is a nice 2 day ride down and back with a lot of beautiful machines on display.

Tom brought up the possibility of getting some free publicity from Gordon Martin of the Chronicle sports events listing. A couple of members offered to notify him, and maybe the Mercury also, of our rides and events. However,....this produced a broad ranging discussion of the club's liability for sponsored events. Michael Bruce pointed out that riding a motorcycle has an assumed risk and that the club would probably not have any liability for accidents. Sounds reasonable; there will be more to come on this subject as members consult legal gurus. Tyrone kept comparing us to camel jockeys (yes, Virginia he is one), but I missed the analogy. Camel shit?

Phil Radford gave the financial report, pointing out that this was normally the low point of the year in membership and funds (\$455.00 in the black with some 200 members). Robert Briscoe, our new Norton Notice editor/printer, agreed to print up some more business cards to facilitate getting new members. Also the club endorsed the practice of sending an extra copy to our advertisers as a "shop" copy to be posted.

Tom asked that all members make a serious attempt to support our local shops, such as Britalia which continues to provide us with a \$25.00 gift certificate for our monthly raffle. This month's raffle was postponed due to absence of the raffle tickets. Tune in next meeting, the goodies won't go away.

Finally, Rich Stevenson brought up a potential conflict in dates between the July 17th old timer's ride, the Laguna Seca races, and the USNOA annual meet in Flagstaff. Hence, the old timer's ride will be on JULY 10TH! Young whippersnappers with old bikes, (all Nortons are old), are also welcome. OK, Art?

Tim Coburn

Presidents Report

PRESIDENT-TOM DABEL

ATLAS SHRUGGED

I have recieved letters from Phil Cox and Les Emery in England pertaining to disenfranchisement. It seems the NOC has rules about this and we need not make our own. Great! Anyone having a copy of N.O.C. bylaws please bring them to the next meeting.

Liability homework assignment: Bring to next meeting your contribution to: Disclaimers, Releases, Incorporation, and alchohol (served by us at Beer Bust).

Thanks Ron Glenn for the branch logo labels.

Film - They get old and the sprocket holes go away. I know of a collection of Bardahl "Indy 500" 16mm films. 30 minutes each of the 50's and 60's years they're gone. Two four hour tapes worth \$30.00 - tape cost but impossible.

As an enthusiast of motor sports I'd like to video record anything I can find. Let me know if you have old films of racing, two wheels or four.

Mount Hamilton is a Norton Road on a sunny Sunday morning. The Porsche ahead misses a shift as he passes another car and when I come up to pass him, I'm in a tight section of the road, wound tight in low and bang....hit second while healed over with rear tire on point of a dash. The tire lit up fishtailing the bike under me. I gathered it up and snook away. The result was soon evident audibly as chain clatter and a snik snik snik when backed off in second. I made a \$30.00 mistake and should feel bad, but then I think of the Porsche's second gear replacement cost. Ha! Ha! see you soon Harvey.

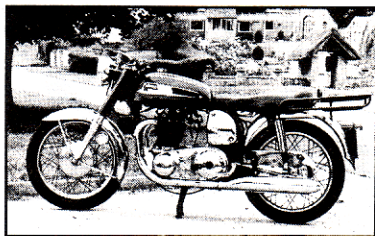

RIDE MARSHALS REPORT

The ride on Sunday, February 13th, started under threatening sky, but soon changed to Norton weather. In my area, (Oakland), the rain was still coming down at 6:00 a.m. that morning, so by 8:00 a.m. when the sun shone I decided to make the run to Sausalito. Nine Nortons showed at the ferry landing and after about an hour of tire kicking we were on the road. Route One gets crowded later in the day, so an early start from the ferry landing is a must.

The last storms have made parts of Route One a little rough, plus gravel and running water. No problems en route up to Point Reyes Station for breakfast and next stop Point Reyes Lighthouse. The ride passed through Inverness, the old watering hole for the Sunday morning ride. Nice road out to the lighthouse and ride is worth the view. This ride was in question right up to 8:00 a.m. Sunday morning with the weather off and on. Hope to see more Nortons next ride and should be organized a little better.

Rich Stevenson

Note: Rich is kicking around the idea of going up the back way to Mount Hamilton, so be at the Howard Johnsons in San Jose a little earlier than the usual time to talk about it.

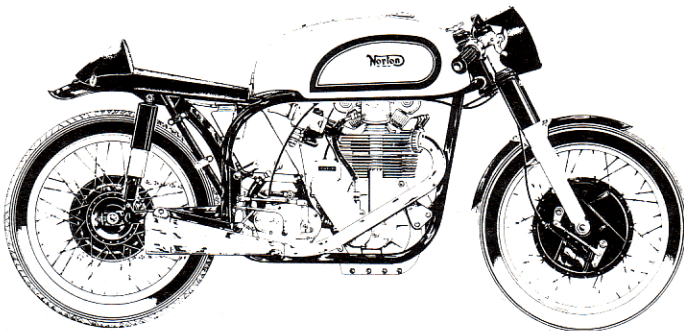
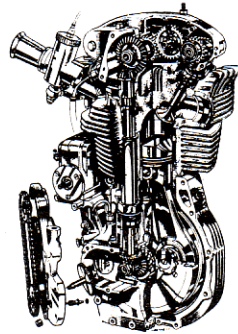
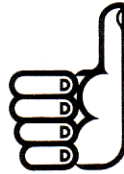

UPCOMING BRANCH EVENTS

DATE	TIME	PLACE	EVENT
March 10	7:30 p.m.	Edinburgh Castle 950 Geary St. San Francisco	March Meeting
March 13	10:00 a.m.	Howard Johnsons intersection of No. 1st and Highway 101 in San Jose	Mt. Hamilton ride
April 14	7.30 p.m.	Rick's Swiss Chalet 4085 El Camino Way Palo Alto	April Meeting
April 17	10:00 a.m.	To be announced	East Bay Hills Ride

NOTICE: In the event of rain on the day of a club ride, the ride is automatically postponed one week. Also, riders should have plenty of gasoline by the scheduled departure time and all "personal problems" should be taken care of.

Paraphernalia



FOR SALE

N.O.C. paraphernalia as follows:
 3" square machine badge.....\$6.00
 lapel pin..... 1.25
 4 1/2" sticker..... 1.00
 2" sticker..... .50
 key fob with club badge..... 1.50

3-color Northern California Branch
 lapel pin..... 1.50

Northern California Branch T-shirts (white shirts with blue and red logo as below) in large and medium sizes only. \$7.50 each, plus a dollar if you want it mailed.



Contact Carolyn Scott (phone (415) 968-5117) at 1970 Latham #14, Mountain View, Ca. 94040 to order by mail. Please send extra money to cover postage, and be reasonable. If you want your items thrown in a thin envelope so that the U.S. Postal Service can do a number on them, send only 20¢ extra. If you want a cushioned envelope like the Post Office sells, you'll have to send about a dollar to cover the cost of it and the postage.

NORTHERN CALIFORNIA BRANCH
 TOOL LOAN-OUT PROGRAM

If you need one or more of the following tools for working on your bike, get in touch with Harry Bunting and arrange to pick them up.

A refundable deposit equal to the replacement value of the tool is required at the time you pick them up.

<u>TOOL</u>	<u>DEPOSIT</u>
Timing cover oil seal guide	\$ 5.00
Rocker spindle puller	\$25.00
Crankshaft sprocket puller	\$12.00
Clutch spring tool	\$12.00
Clutch locking tool	\$18.00
Valve spring compressor	\$22.00

Harry Bunting (415) 968-2020 (home)
 1401 Gilmore St. (418) 735-1550 x2394
 Mountain View, Ca.

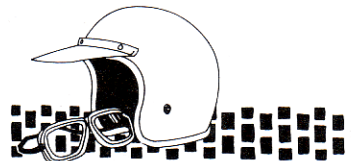

Pappy

Amazing as it may seem, one of our members has recently made contact with the spirit of the late J.L. Norton. In seance after seance, the fiesty old man told us what it is like in the other dimension. He said we could call him "Pappy" since we were in the club and he has agreed to give tech tips and answer letters from NOC-CERS all over the world!

Listening in the darkness, club members were startled and amused to hear revelations such as these.

- * Yes, there is a Spares Scheme where he is and the prices are reasonable.
- * None of the women wear any clothes.
- * There is no speed limit, so you can race down twisty roads like a bat out of Hell, throwing Norton into the turns. Better still you can take big chances as you scrape the pegs in the turns because even if you hit anything or ride off a cliff there's nothing to worry about because you're already dead!
- * The beer is inferior. Something about the water being filtered through clouds instead of dirt.
- * No taxes, that's right, no Inland Revenue, as "Pappy" called them, and no representatives of the government in general. There's no CHP's, no stop signs, no emmission controls, no mother-in-laws, no lawyers and no fat people!
- * No Japanese motorcycles allowed, nothing personal he said, they just realized that if they let one in they'd have to let them all in and well there isn't enough bloody room!
- * No pollution, no trash, and nothing smells bad, even clouds of smoke blasting from your silencers smell like char broiled steak and oil leaks beneath the engine smell like fresh coffee.
- * He plays cards and bench races with his buddies, Mr Vincent, Mr Brough, Mr Harley, Mr Turner, Mike the Bike, Count M.V. Augusta and Fred Velloctette.
- * "Pappy" said how the sound of a bunch of Nortons still warms his heart and that Heaven waits for all of us if we just play our cards right, and remember never to choke in the turns.



So, come on Nortinos, here's your chance to ask "Pappy" all those questions about Norton you always wanted to know, but were afraid to ask! The first of your "Dear Pappy" letters will appear in next months rag!

Hall-Burdette

MOTORCYCLES



We have been selling and servicing Nortons since 1948 and have a good supply of parts and accessories, both new and used. Our mechanic, Bob Bennett, has been repairing Nortons for over 20 years and is a recognized expert. Thor Berke, our parts manager, has a thorough familiarity with all Norton parts and accessories.

2010 DEL PASO BLVD.
SACRAMENTO, CALIFORNIA 95815
PHONE (916) 925-1797

Norton

I would like to thank the dealers who have advertising on this page for their support of our club. To the members I would like to say, drop in and check them out; and, if you buy, mention that you saw their ad. Your patronage is appreciated!

Also, there is more space available for anyone out there who might like to advertise. The rates are \$35 for 6 months and \$60 for 1 year. Who could ask for a better deal.

Call or write: Dave Kerst, 371 Hickory Ave., Tracy CA. 95376 (209) 835-7468 until 2PM or (415) 443-6300 between 4PM and 10PM.



T.T. MOTORS

Norton Owners - T.T. specializes in European motorcycles and offers complete parts, service, and machine shop for all the wonderful bikes we sell.

Stop by and visit and check us out!

- * Complete line of British tools
- * Manuals and spares for your Norton
- * Speed Equipment:

Megacycle and webcam camshafts
Single Mikuni kits
Exhaust port repair \$45 each
Valve jobs and port work
Cylinder boring and surfacing

- * 10% discount on all parts (except Lucas) to N.O.C. members

2800 Adeline Street
Berkeley, CA 94703
9 a.m. - 6 p.m. Tues. - Sat.

845-8235

TRIUMPH

Norton MOTO GUZZI DUCATI
MUNROE MOTORS, INC.

MOTORCYCLES
SALES - SERVICE - PARTS

Munroe has three mechanics that are familiar with Nortons and have been for a number of years. We can replace exhaust ports with the head on the bike and don't know of anyone else who can. The job looks like original factory! Call for a quote on shop prices. We also have a good Norton parts supply.



TECH TIPS



Greetings, fellow Norton riders. Having taken a wrench to my Commando a few times in past and future, I feel qualified to bring your attention to a serious problem which may have been overlooked on your machine. Most people wouldn't dream of running their bikes for long without an air cleaner, especially in dry, dusty California weather. But is the air entering your crankcase as clean as that in your combustion chamber? The air should be clean if you have a stock airbox setup, as the air is cleaned by the air filter. When I bought my roadster (John Player replica) in 1978, its crankcase breather pipe was dangling in the breeze, as the machine had a single Mikuni carburetor setup. It didn't dawn on me that on every compression stroke gritty air was being drawn into and filtered by the oily innards of my engine. Several rebuilds later, my empty wallet slapped me in the face and said "Hey bozo! put a K & N crankcase breather air filter on that dangling breather pipe". So I went to my favorite well stocked motorcycle parts store and bought, (on credit), a 1/2" O.D. filter and a 5/16" to 3/8" hose adaptor (Norton Part No.062617) and installed it in less time that it took to write this tech tip. The result? One clean engine. Ensure that you regularly clean the filter to prevent unforeseen problems. May your windy road stretch on for a long way.

Mike Wenstrom-No.169/1
3500 Flora Vista Avenue No.11
Santa Clara, CA 95051

TECH TIP CORRECTION

It looks like only one person, Harvey Loucks to be specific, noticed an error in last month's tech tip in which I discussed the installation of a cylinder compression plate. I said that after the installation of a compression plate the valve lash would have a theoretical increase of .026" (figured on a .030" thick compression plate and the 1.13 to 1 rocker arm ratio) when in fact the theoretical increase would be .034". The reason is because the rocker arms on the Norton heavyweight twins increase the valve lift by a factor of 1.13. For instance, the Combat cam inlet lobe lift is .390" while the valve lift is .441" (.390 times 1.13=.441).

The last sentence in that tech tip was "I'll bet you're confused now!" but it appears that I was the one who was confused. Now all I have to do is go out to my garage and turn all my rocker arms around in the head and get some real power!

Gene Austin
985 E. Grant Pl.
San Mateo, Ca. 94402

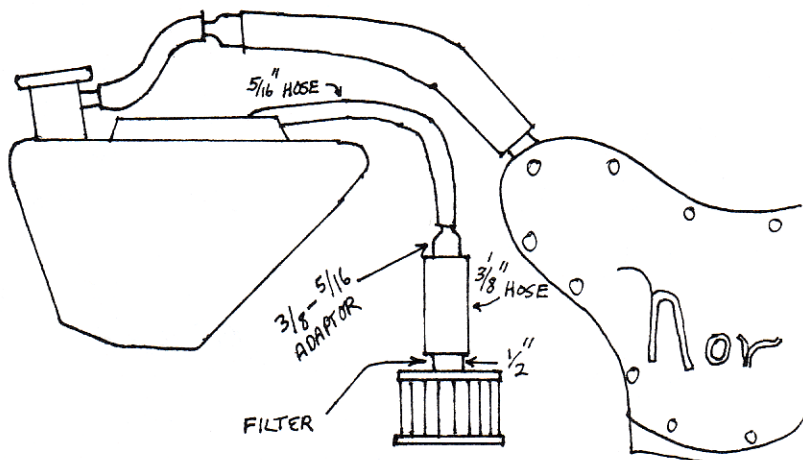

WHEEL DEAL TRADE

THERE IS NO CHARGE FOR PRIVATE ADS. NORTON-RELATED ADS RUN FOR TWO MONTHS, UNLESS RESUBMITTED.

WANTED:

Stock 850 MKIII exhaust pipes with crossover pipe.

David Salomon (415) 550-1864

FOR SALE: (reduced from last month)

1. Transmission gears, \$15 each.
2. Lucas RITA ignition, less rotor, \$30
3. Commando connecting rods, excellent, \$30 each.
4. New 850 +.020" piston set, \$55.
5. Commando clutch basket, \$15.
6. TLS brake backing plate, \$20.
7. Grab rail with clamps, perfect, \$15.
8. Atlas seat, original cover, \$35.
9. Roadster seat with new upholstery, \$40.
10. Brand new pair of Atlas mufflers, \$95.
11. Cush drive rear wheel, perfect, \$20.
12. Stock valves, \$6 each.
13. Alternator stators, \$30 each.
14. Hardened Commando clutch hub, \$25.
15. P-11 engine, less head, \$90
16. Brand new 33 piece forged and polished 1/2" drive socket set, \$100 new, \$35.
17. Chrome oil tank for P-11 or N-15, \$15.
18. Commando horn, \$8.
19. Set of those expensive Lucas turn signals, \$45.
20. Excellent 750 head, \$98.
21. "S" model central oil tank, \$20.
22. Red Atlas gas tank, excellent, no dents, \$65.
23. Original factory 750 or 850 shop manual, \$15.
24. Every other part you could imagine for your Norton at ridiculously low prices.

Ya ain't never gonna see Norton parts this cheap agin, so git off yer duff an' give me a call between 6 & 9 P.M. an' stock up on stuff you know yer gonna need!

Harvey (408) 255-7356 6-9 P.M.

FOR SALE:

1. Black Bell Star II, size 7 5/8, in excellent condition.
2. All original John Player Norton fiberglass dual headlamp fairing, windscreen, seat, front fender, and petrol tank cover with locking cap as provided to Norton by Avon. Includes steel petrol tank, all bracketry and fasteners, headlights, tail light, turn signals, clip-on bars, mirrors, wiring and switches, etc. Will sell as a complete set only. In excellent condition. \$1,200.
3. Original "black chrome" JPN exhaust pipes with crossover and unused "black chrome" JPN silencers.

Richard Eyler (408) 289-4452, work
(408) 338-3058, home

FOR SALE:

'74 850 Roadster with Windjammer fairing, Dunstall exhaust, and leather seat. 20,000 miles on bike, 2,100 miles on engine rebuild, exceptionally clean. \$1,200 or best offer.

Keith Ingle (408) 259-3530 (leave message with Lynne)

FOR SALE:

'73 Combat Interstate with 17,000 miles, new paint (striping & decals correct), late model mufflers, Colorcraft cafe fairing, mechanical details, repair records, & spares. \$1900 or best offer.

Tom Kelly (916) 877-6450 weekends
(415) 534-6383 weekdays until
7 A.M.

FOR SALE:

Red '74 850 Fastback in perfect shape, with Boyer ignition and Amal MKII carbs. Included are many extra parts, original factory service notes, manuals, Belstaffs, Marsee bags, tools, etc. Serious offers of \$1,950 or so.

Gary Broeder (415) 949-2291



FOR SALE:

1. 850 Commando frame. November '73, SN #310370, \$200.
2. 850 Commando engine, complete and good standard bore, SN #310370, \$295.
3. 850 Commando frame. March '74. First registered March '75. SN #313960. Has slight kink in left down tube, \$125.
4. Complete 850 front end. Wheel, forks, sliders, disc, caliper, master cylinder, brake hose, lever, wheel spindle, the lot only \$240.
5. 850 top & bottom triple clamps, (yokes), \$40.
6. Stiffen up your 750 swinging arm with an 850 version, \$40.
7. 850 wiring harness, complete with handle-bar control cables, \$40.
8. 850 Box-section head steady, convert your 750, only \$25.
9. 850 square type rear light unit, complete with indicators & lens, \$35.
10. 850 stainless rear fender, excellent condition, \$25.
11. 850 stainless front fender with stays and center bracket, \$25.
12. 850 oil tank, \$30.
13. Stock Commando air cleaner cases, \$10.
14. 750 Commando front fender, chromed with center bracket, \$10.
15. 750 Roadster swinging arm, \$25.
16. Hi-rider gas tank, \$35.
17. Fastback center stand, \$20.
18. Commando engine sprocket pullers, good and strong, made them myself, \$10.
19. Black leather motorcycle jacket, size 38, 40 inch chest, hardly worn, \$65.
20. 1964 650cc Triumph replica II Special completely rebuilt, new everything, cherry, \$1,500.
21. Triumph stock dual seat, recovered, \$50.

Phil Radford (408) 293-4548

For Sale 1973 Norton "Interstate"
Dunstall exhaust, Barnett clutch
new battery, custom paint, Dunlop
tires. Beautiful Bike, less than
300 miles on lower engine rebuild.
Call 835-8500 Ext. 2254 (Weekdays)
or 583-5218 Michael E. Malekos

FOR SALE:

Norton Parts:

1. Early 70's Commando motor, built and raced by Reg Pridimord. Rebuilt prior to sale, less than 20 miles. Standard bore Hepolite pistons Dykes-Type rings, S & W valve springs, Dunstall midrange needle bearing cam, needle bearing rockers, sealed guides. Speedation ignition. All fins intact. FIRST OFFER
2. Amal concentrics with custom manifold for same motor, \$80.00.
3. Commando gearbox with kickstart, \$100.00.
4. Two into One race pipes with megaphone for same engine, \$40.00
5. Complete primary drive with case and lightened diaphragm clutch, \$100.00
6. Entire package \$600.00 or trade same for 59 Manx seat, rubber goods, mud guard, oil tank or shop time on same.

Lance Mason (805) 962 2970, days

FOR SALE:

1975, 850 MK III, White with Red and Blue stripes, low rise bars, all stock parts, 25,000 miles, clean, \$1,350.00.

Chase Heckman (415) 924 7475

Evenings 6 p.m. - 9 p.m. and weekends

WANTED:

For 1973, 850 Roadster. Front rim, headlamp shell, 1 turn signal, outer primary case, replacement seat cover.

Ken Ward
1232 Pecos Way
Sunnyvale, CA
(408) 733 5749 - Nights
(408) 742 8245 - Days

WANTED:

Fastback seat and tail section

Michael McKinney
(415) 648 2349

FOR SALE:

2 complete Amal 32 mm carburetors. All new except floats and float bowls. Offer around \$100.00

Tom Borman
(408) 255 5197 - Evenings



281 Anderson Road
King of Prussia, Pa.
19406

(215) 265-2986

Dear Fellow Bike Jockeys,

January, 1983

Castre, Inc., in partial sponsorship of my 1983 professional Formula One Road Race program, has agreed to allow me to make their fine, race tested products available at dealer cost to recognized, organized clubs such as yours.

Riding a motorcycle for profit and/or fun has been very costly this past year for you and I. Castre has also had to cut back on their race support program, as have many fine companies in our industry. This club offer is one way I'm trying to regain those cuts, spread the Castre name and show appreciation for club support over the years. I believe your membership will appreciate the 25% to 35% discounts offered in the enclosed catalog.

At present this is a one time offer for this year, "with possibilities in the future, depending on how it goes," according to Castre's President, Casey Koehler.

If you send a check, made payable to me, with your order, I will pay freight. If you order twelve or more items I will pay freight and COD charges. If you order eleven or less items you will have to pay freight and COD charges, unless prepaid as explained above.

I would consider any order for more than \$250.00 as a club sponsorship and would be proud to put your club sticker on my Formula One bike in appreciation and hope you will introduce yourself to me at one of the many pro and semi-pro road races I'll be making this year - with your help. Send one dozen stickers as I use different fairings.

Have a dynamite year and thank you very much.

Don McAuliffe
Professional Formula One Motorcycle Road Racer

DMM/hs
Encl: Castre Catalog & price list

PS: I am approaching my other sponsors for the same opportunity.
'Stay Tuned'

I started on a Norton 850

Norton OWNERS SENSE OF HUMOR TEST NO. 78
 "THE OIL LEAK"

